

XL-Roof fans E280

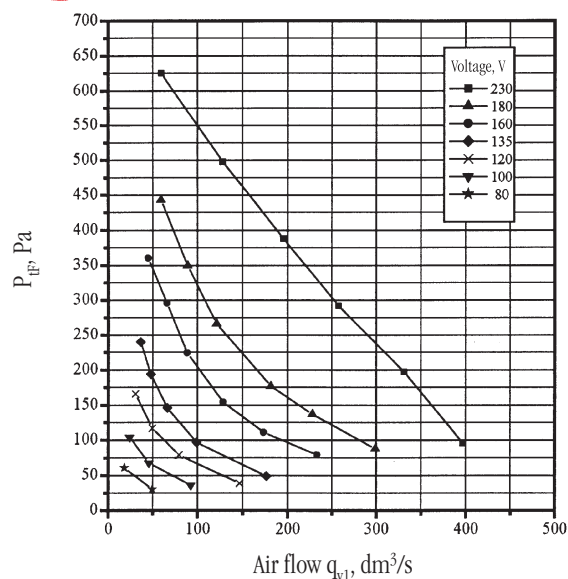

E280P/200/IS/700

VTT Testing report
No RTE 1813/00



E280P/200/IS/500

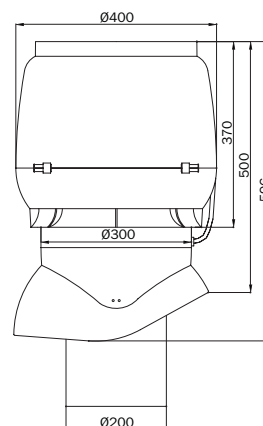

[More about product](#)

NOISE LEVEL

E280P/200/IS/700		100V	120V	135V	160V	180V	230V
q _{v1}	dm ³ /s	45.8	79.6	99.2	128.5	181.4	257.8
p _{st}	Pa	68	80	98	155	177	295
P _e	W	86.0	117.0	145.3	200.7	240.4	330.7
η _e	-	0.036	0.054	0.067	0.099	0.134	0.230
n	1/min	877	995	1126	1424	1654	2217
L _{wa3}	dB	53.9	50.4	57.8	62.2	52.9	58.7
L _{wa25}	dB	60.6	61.2	61.6	65.1	66.4	71.7
L _{wa50}	dB	49.5	51.0	54.2	60.6	63.6	69.5
L _{wa100}	dB	51.2	53.5	56.8	62.5	67.3	74.9
L _{wa200}	dB	47.1	49.4	53.1	59.2	64.3	73.3
L _{wa400}	dB	42.4	45.5	49.3	55.8	60.8	69.1
L _{wa800}	dB	37.7	41.5	45.7	53.0	57.7	66.2
L _{wa1600}	dB	33.6	36.1	40.5	48.3	53.1	61.6
L _{wa}	dB	62.3	62.9	64.9	69.7	72.3	79.6
L _{wa(A)}	dB (A)	52.9	55.0	58.3	64.3	69.1	77.3

E280S/200

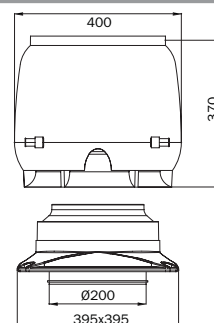

[More about product](#)

ELECTRICAL DESIGN

Fan Type	E280
Power Input	225W
Current	1,23A
Nominal Voltage	230V/ 50Hz
Speed	2700r/min
Capacitor	7µF
Fan Type	R2E 280-AE
Speed Controller	Thyristor or transformer

Roof fans table

Roof Fans		Air Flow $q_{v1}, \text{dm}^3/\text{s}$													Rotation speed r/min		
		25	50	75	100	125	150	175	200	225	250	275	300	350			
E80	Ø125	160	113	57													1700
E120	Ø125	240	200	135	65						Maximum total pressure P_{tF}, Pa					2450	
E150	Ø125	190	149	105	50												1700
E190	Ø125	285	248	185	120	85	38										2450
E220	Ø160	-	295	262	224	180	147	110	70								2600
E250	Ø200	-	480	445	405	370	325	277	225	175	130	75					2600
E280	Ø200	-	640	585	540	500	460	425	380	335	300	270	230	175			2700
E310	Ø200	-	240	230	220	210	200	185	165	150	130	115	90	45			1430

Fans with inner pipe Ø 125 mm

Area of use

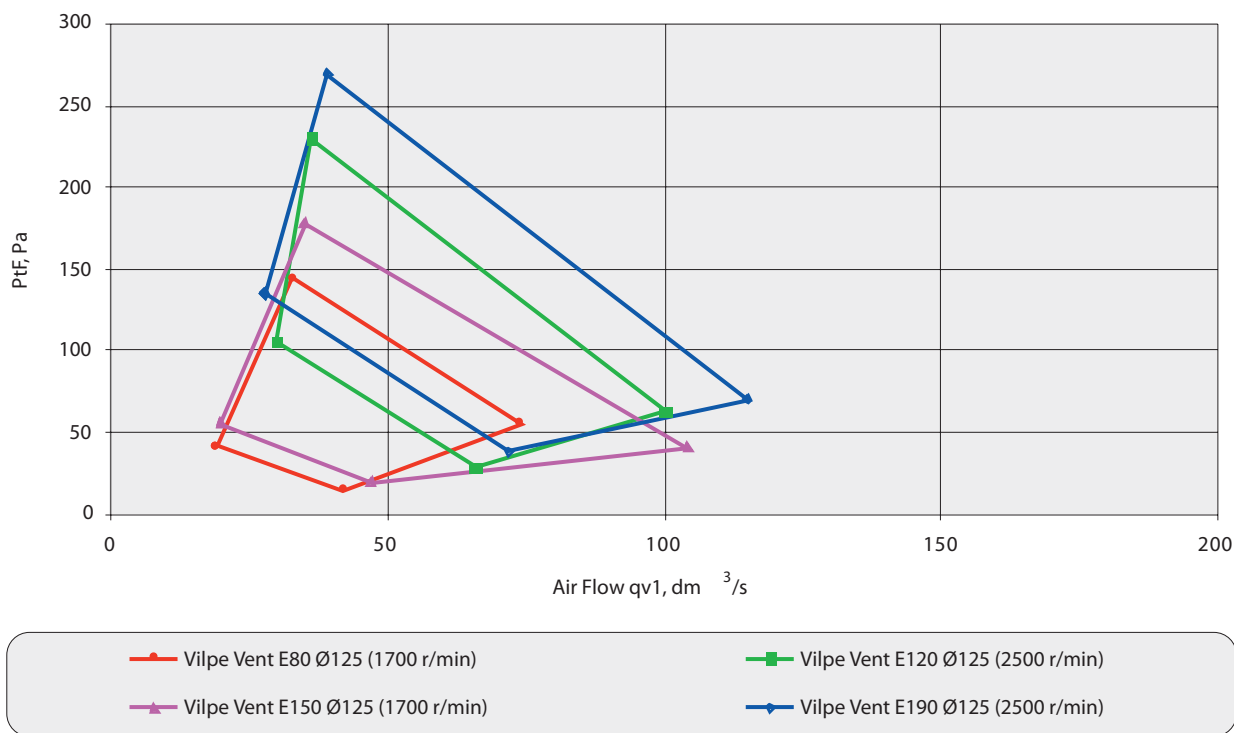

Fans with inner pipe Ø 160 mm

Area of use

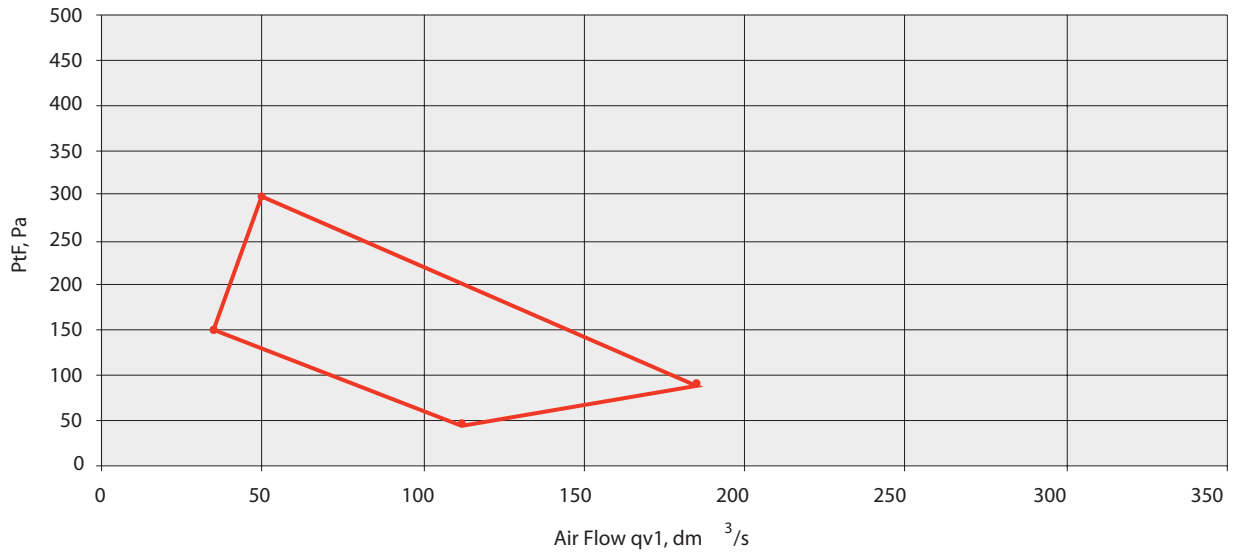

Vilpe Vent E220 Ø160 (2600 r/min)

Fans with inner pipe Ø 200 mm

Area of use

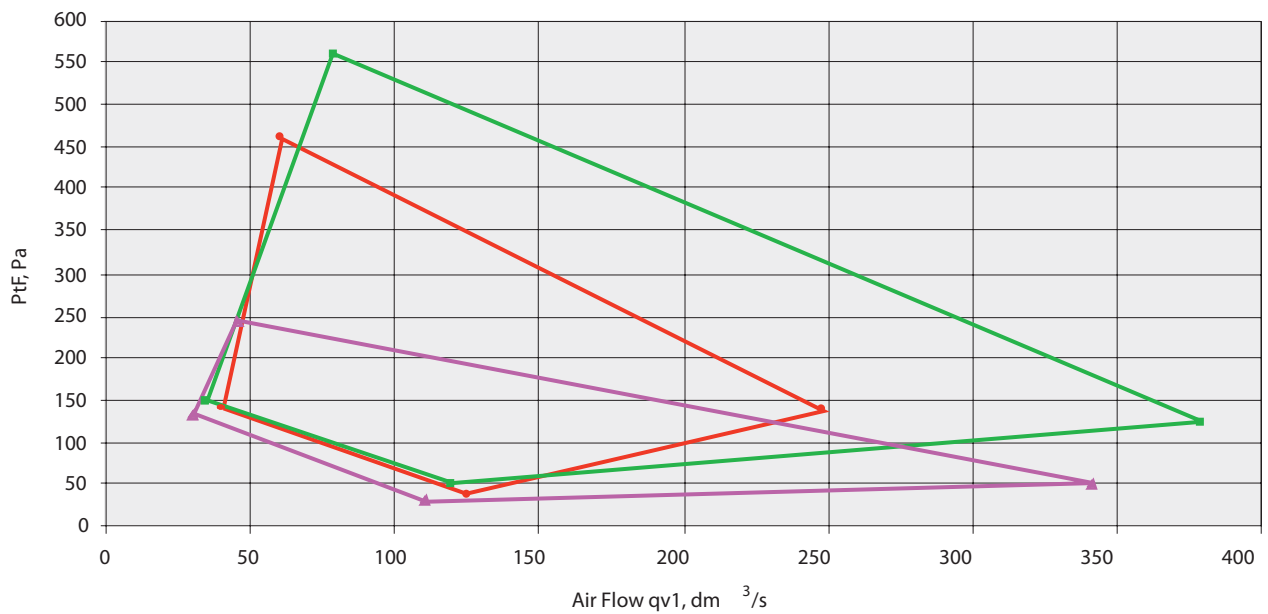

Vilpe Vent E250 Ø200 (2600 r/min)

Vilpe Vent E280 Ø200 (2700 r/min)

Vilpe Vent E310 Ø200 (1430 r/min)

Electrotechnical information

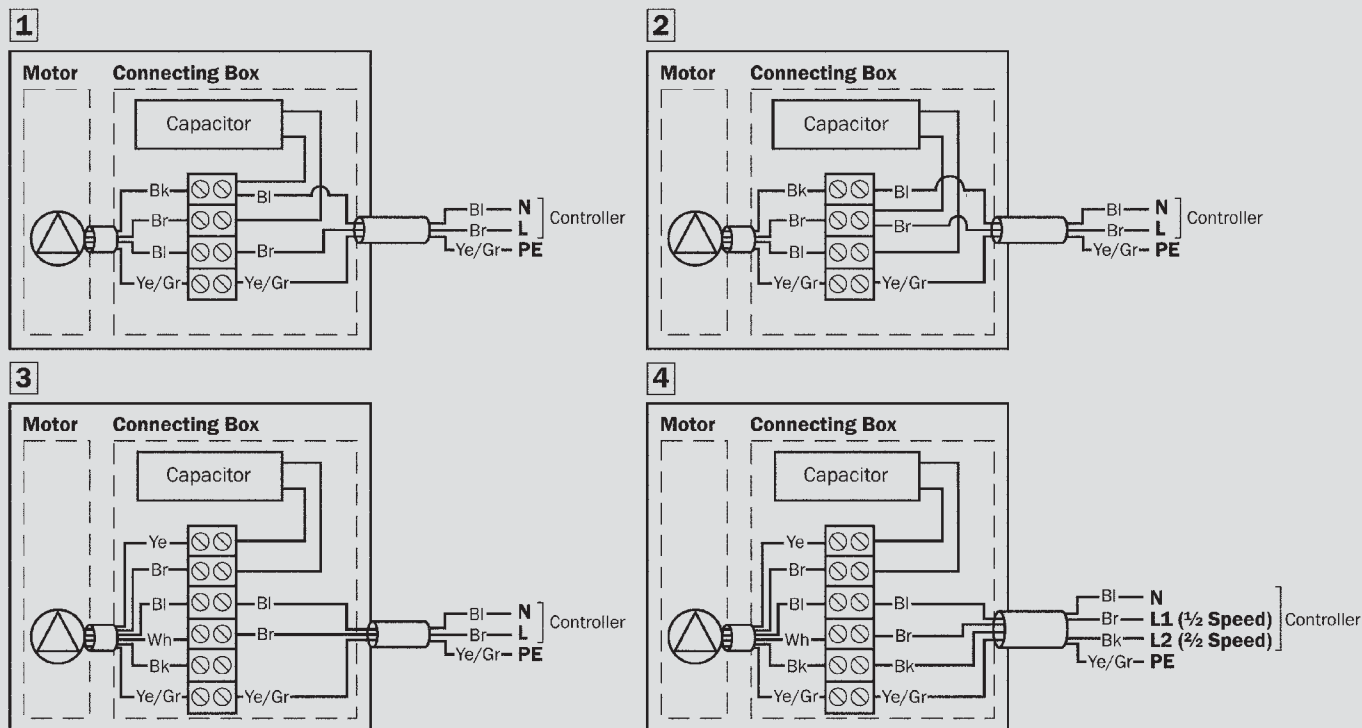

1 E120, E190, E220, E250, E250-R4E, E280, E280-R4E, E310-R4E

2 E80 (.....Serial Nr: E08099999), E150 (.....Serial Nr: E15099999)

3 E80 Radon/Toilet, E80(Serial Nr: EA80100000.....), E150(Serial Nr:EA150100000.....)

4 2-Speed Top Fan

VILPE model	Power input	Current	Voltage	Capacitor	Rotating speed	Motor type
E80						
E080099999	45 W	0,23 A	230 V/50 Hz	6 µF	1700 r/min	R2E 190-AO 26
EA80100000	57 W	0,25 A	230 V/50 Hz	2 µF	1850 r/min	R2E 190-AO 04
E150						
E150099999	45 W	0,23 A	230 V/50 Hz	6 µF	1700 r/min	R2E 190-AO 26
E150100000	57 W	0,25 A	230 V/50 Hz	2 µF	1850 r/min	R2E 190-AO 04
E120	58 W	0,26 A	230 V/50 Hz	2 µF	2500 r/min	R2E 190-AO 26
E150	45 W	0,23 A	230 V/50 Hz	6 µF	1700 r/min	R2E 190-AO 26
E190	58 W	0,26 A	230 V/50 Hz	2 µF	2500 r/min	R2E 190-AO 26
E220	85 W	0,38 A	230 V/50 Hz	3 µF	2600 r/min	R2E 220-AA 40
E250	155 W	0,7 A	230 V/50 Hz	5 µF	2600 r/min	R2E 250-AS
E250-R4E	43 W	0,2 A	230 V/50 Hz	1,5 µF	1420 r/min	R4E 250-AH
E280	225 W	1,23 A	230 V/50 Hz	7 µF	2700 r/min	R2E 280-AE
E280-R4E	78 W	0,35 A	230 V/50 Hz	2,5 µF	1420 r/min	R4E 280-AD
E310-R4E	105 W	0,47 A	230 V/50 Hz	4 µF	1430 r/min	R4E 310-AF
E80 R/T	57 W	0,25 A	230 V/50 Hz	2 µF	1850 r/min	R2E 190-AO 04
2-SPEED	57 W	0,25 A	230 V/50 Hz	2 µF	1850/2450 r/min	R2E 190-AO 04

Safety

instructions

Receiving inspection

Check if there are damages due to the transportation. If so, please contact the carrier without delay. Make sure that the delivery is complete and identical with the order.

The speed controller has to be bought separately and it should be recommended by the fan producer.

Speed controller

The fan can be speed-controlled by voltage variation. Normally, the speed is controlled by a step transformer or a stepless thyristor regulator. Please note, that an unfit thyristor may cause jamming and noise especially in low-speed use.

Safety direction

The fan has to be installed on the roof so that maintenance and service can be safely done. The fan must be installed in such a way that no moving parts can be touched.

The fan may only be installed by a qualified electrician.

The fan is not designed for transporting hot, explosive or erosive gases, grinding dust or similar.

The main power must always be switched off before the fanhood is opened for service or repair.

The special-plug has to be plugged out and the shelter put on the plug.

Be sure, that the impeller is fully stopped before opening the fan hood.

The motor unit has to be handled carefully.

After disconnecting the special-plug and opening the slide locks, the motor unit is totally free.

Use always original spare parts.

Electrical installation

A coupling box has to be used between the rubber cable and the fixed coupling. There must be a contact breaker in the coupling box. The rubber cable must be pull-out safely fixed in the box, meaning that there is a fitting cable clamp in the coupling box.

The fan has a built-in thermocontact and the switch on function is operating automatically.

Before use

The electrical installation must be totally finished.

The earth connection has to be in use.

There must not be any foreign objects in the fan hood or impeller.

Check that the electrical conduit is properly installed.

When taking in use - check

The measured electrical results must not be higher than those shown on the fan.

Rated current must not be higher than 5% with rated voltage. Eurovoltage in accordance with DIN IEC38 max. current +6%, - 10%.

No foreign noises are heard from the fan.

Service - Reparation - Guarantee

The main power must always be switched off before the fanhood is opened.

We recommend inspection of the impeller and removal of possible foreign objects at least once a year. The omitting can result in damage in the bearings. The bearings are capsuled, lubricated and completely maintenance-free. Always use original spare parts. The rubber cable must be pull-out safely fixed after mounting the spare part. If the impeller is broken, a whole new fan-engine has to be installed.

The cover on top of the hood has to be opened if the fan, cable or capacitor has to be disconnected. When closing the cover be sure that the rubber gasket under the cover is properly in place.

The guarantee is valid one (1) year accordingly to the clauses of the producer or importer of the fan.

In case of problems

The main power must always be switched off, before the fanhood is opened.

The fan is not running - check

- That the electrical installation is correct.
- That the impeller runs easily.
- That there is no ice or foreign objects in the fan.

The fan is designed for continuous use!

The capacitor may be damaged (inspection is to be done only by a qualified electrician)

The fan is noisy

The impeller must be intact and clean. Unbalance may cause vibrations.

There may be foreign materials in the impeller e.g. pieces of insulation.

Water in the ventilation system

Pipe must be completely insulated in cold areas with minimum of 5+5cm insulation boards. No moisture barrier may be installed on the insulation.

The fan is designed for continuous use. Condensation in the pipes may occur if the fan has been switched off.

